

Cadet European Judo Cup Cluj - Napoca 2019

Cluj - Napoca (ROU), 04-05 May 2019

-50 kg

30 Judoka

POOL A

1 HOLOBORODKO, Mykyta UKR 1 HOLOBORODKO, Mykyta

9 ALEKSIC, Nemanja MNE 2
25 IOZEF, Tomer Haim ISR

5 VAN HARTEN, Jochem NED 3
21 OUZAN, Royi ISR

13 MIHAI, Robert ROU 4
29 DZIAMIDAU, Yahor BLR

POOL B

3 BARCZIKAY, Akos HUN 5
19 FEIGL, Guy ISR

11 DEGHNOUCHE, Mohamed-Lamine FRA 6
27 SOVA, Vadim ROU

7 PETRUZZELLI, Flavio ITA 7
23 ARCHONTOPOULOS, Vasileios GRE

15 ESENOGA, Yunus Emre TUR 8
31 NIKOLIC, Aleksa SRB

POOL C

2 MATEI, Alexandru ROU 9 MATEI, Alexandru

10 FRONTAUREA, Matteo ITA 10
26 BECIRAGIC, Refik MNE

6 MARDUSEVICH, Uladzislau BLR 11
22 KOCABEY, Azmi TUR

14 KUZNETZOV, Daniel ISR 12
30 CHRISTODOULIDES, Petros CYP

POOL D

4 ZELIANKO, Dzmitry BLR 13
20 BLASZCZAK, Igor POL

12 LARKIN, Danylo UKR 14
28 SHETRIT, Maor ISR

8 LEDJANSKI, Ivan SRB 15
24 ANDREINI, Pietro ITA

16 HANGAN, Darius ROU 16
32 GABOR, Aron HUN

Pool A - Winner
Vainqueur / Sieger

Pool B - Winner
Vainqueur / Sieger

Pool C - Winner
Vainqueur / Sieger

Pool D - Winner
Vainqueur / Sieger

1.

Results
Résultat / Platzierungen

- 1.
- 2.
- 3.
- 3.
- 5.
- 5.
- 7.
- 7.

Repechage / Trostrunde

[A1] _____ 29 _____ 33

[B1] _____ 30 _____ 34

[C1] _____ 31 _____ 35

[D1] _____ 32 _____ 36

[38]

[37]

3.

3.

Cadet European Judo Cup Cluj - Napoca 2019

Cluj - Napoca (ROU), 04-05 May 2019

-55 kg

54 Judoka

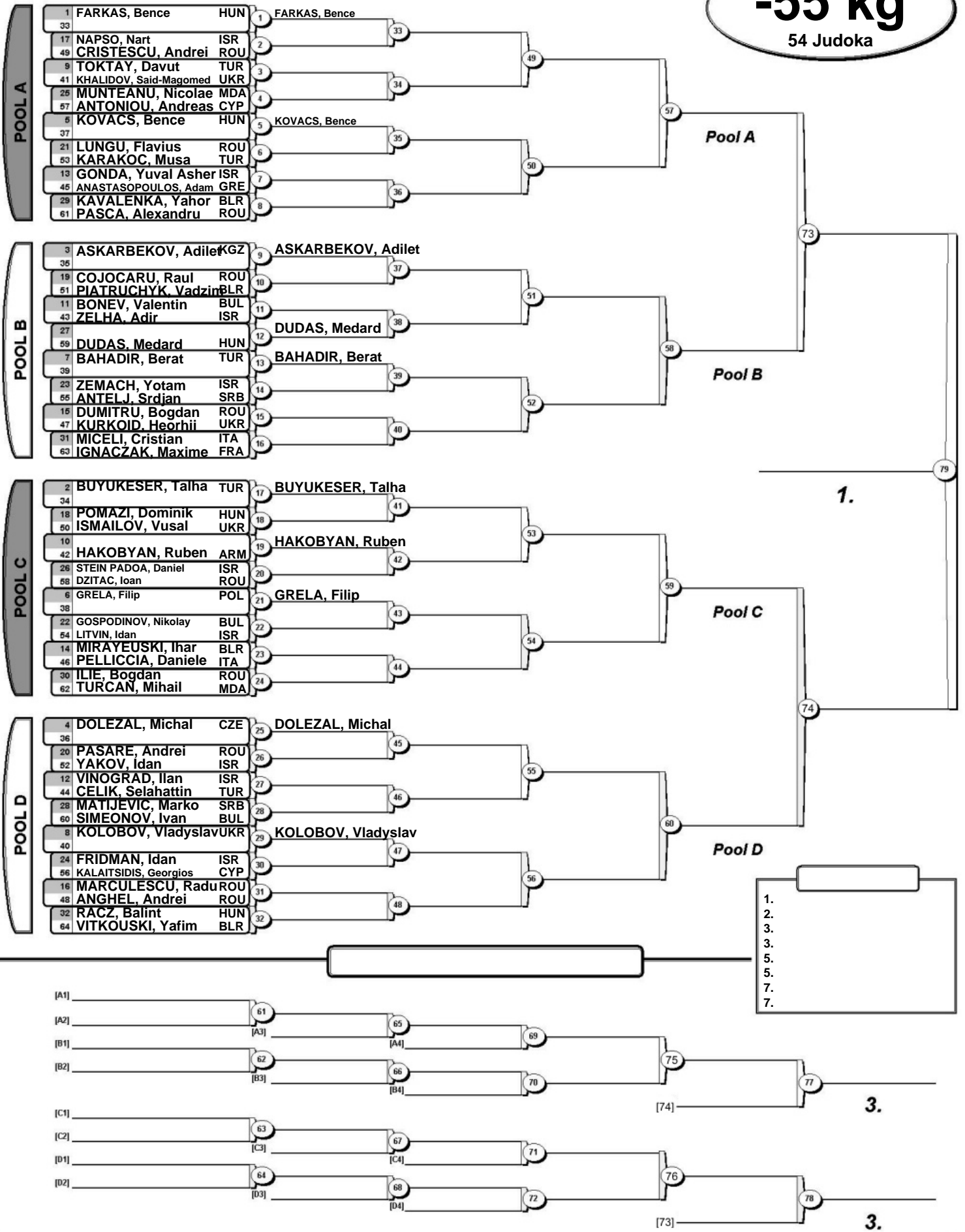

- 1.
- 2.
- 3.
- 5.
- 5.
- 7.
- 7.

Cadet European Judo Cup Cluj - Napoca 2019

Cluj - Napoca (ROU), 04-05 May 2019

-60 kg

62 Judoka

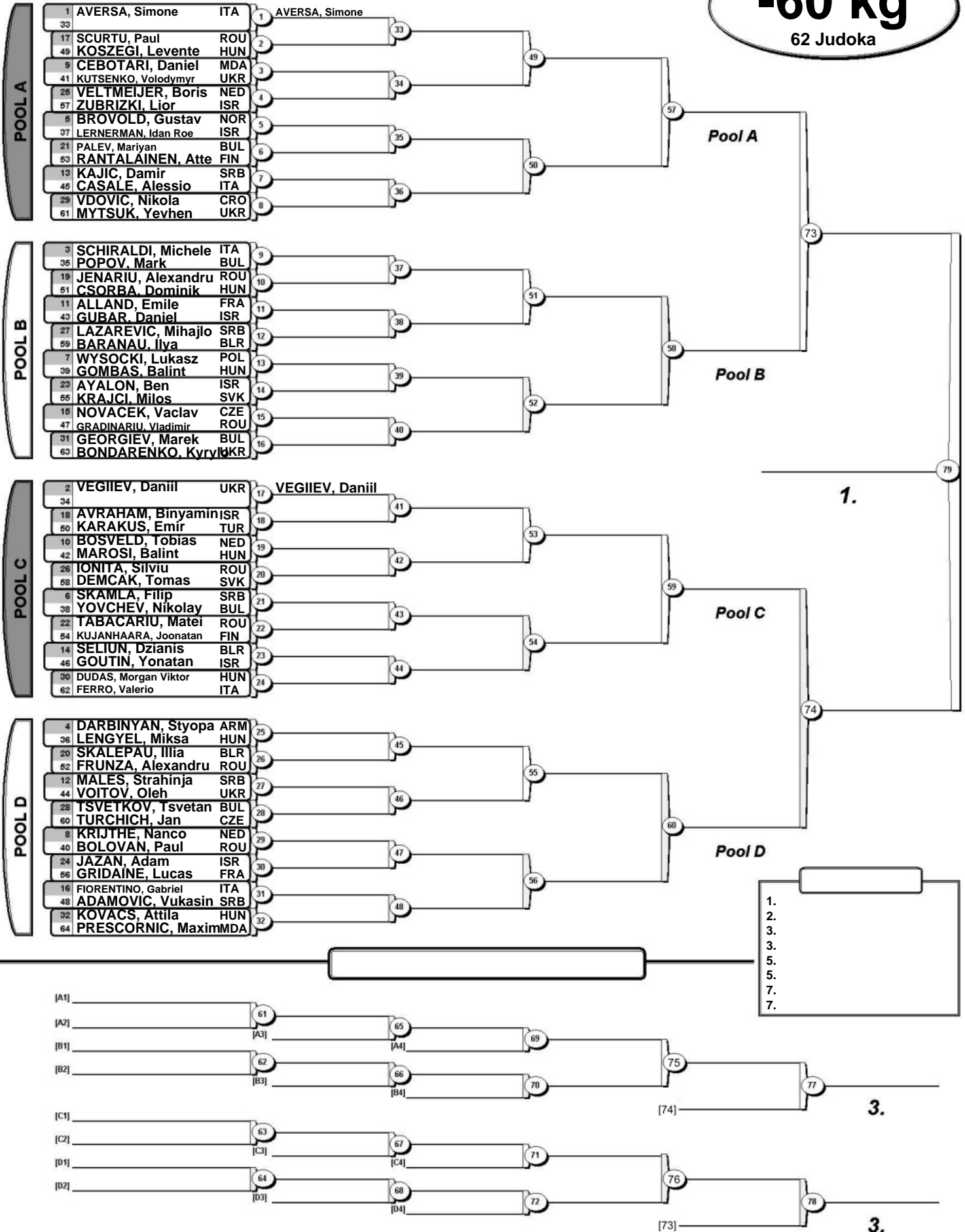

Cadet European Judo Cup Cluj - Napoca 2019

Cluj - Napoca (ROU), 04-05 May 2019

-66 kg

58 Judoka

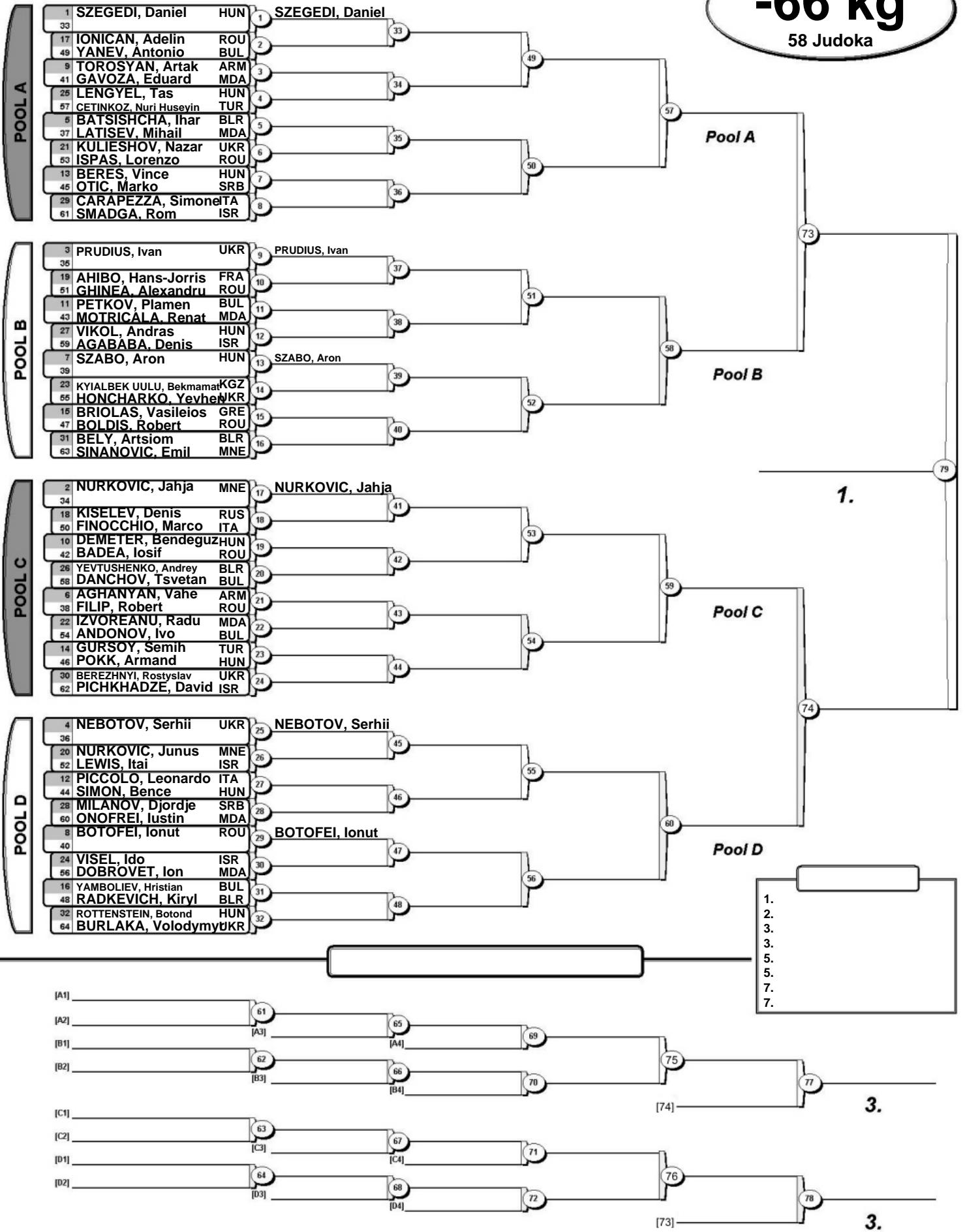

Cadet European Judo Cup Cluj - Napoca 2019

Cluj - Napoca (ROU), 04-05 May 2019

-73 kg

54 Judoka

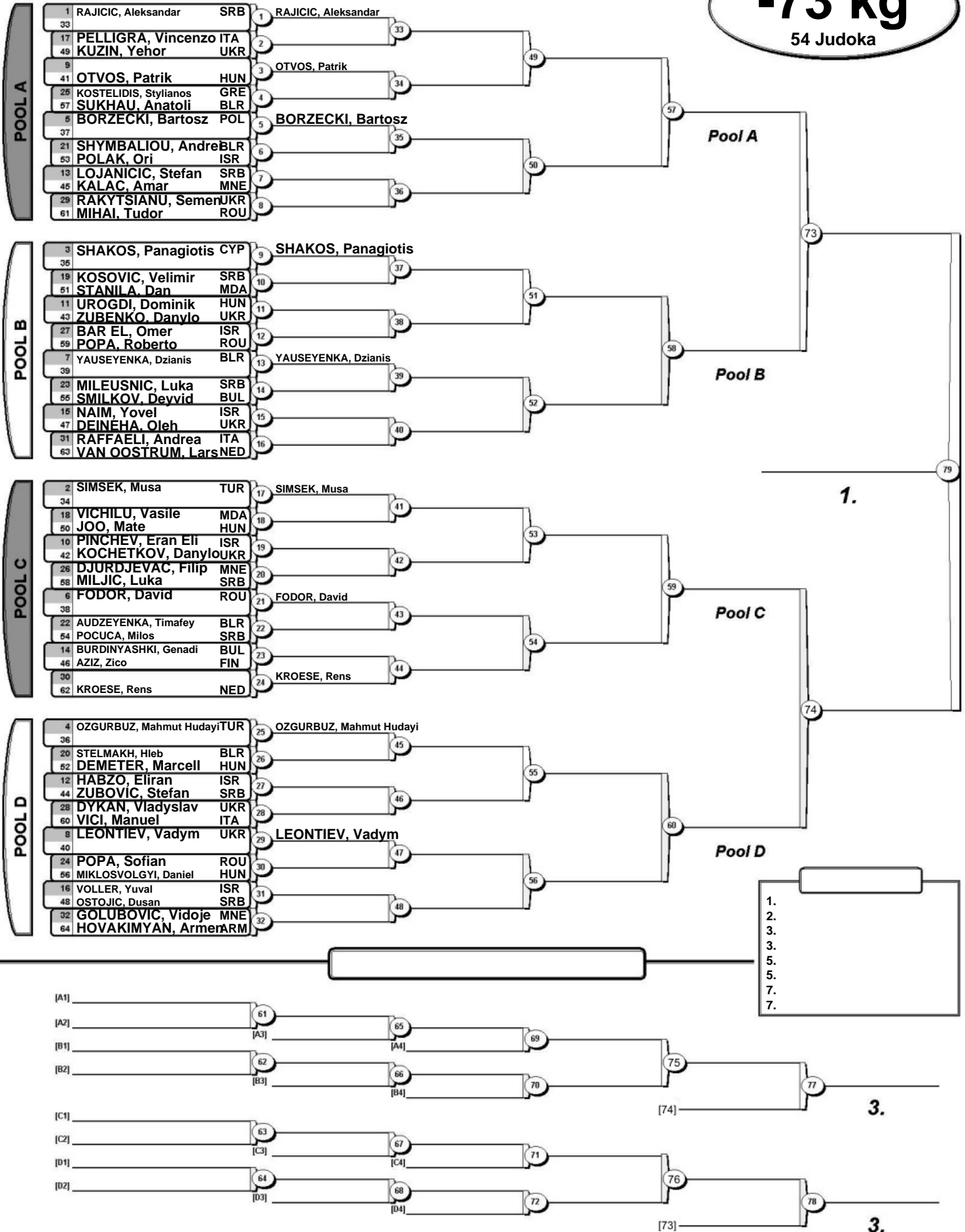

Cadet European Judo Cup Cluj - Napoca 2019

Cluj - Napoca (ROU), 04-05 May 2019

-81 kg

30 Judoka



1.

Results
Résultat / Platzierungen

- 1.
- 2.
- 3.
- 3.
- 5.
- 5.
- 7.
- 7.

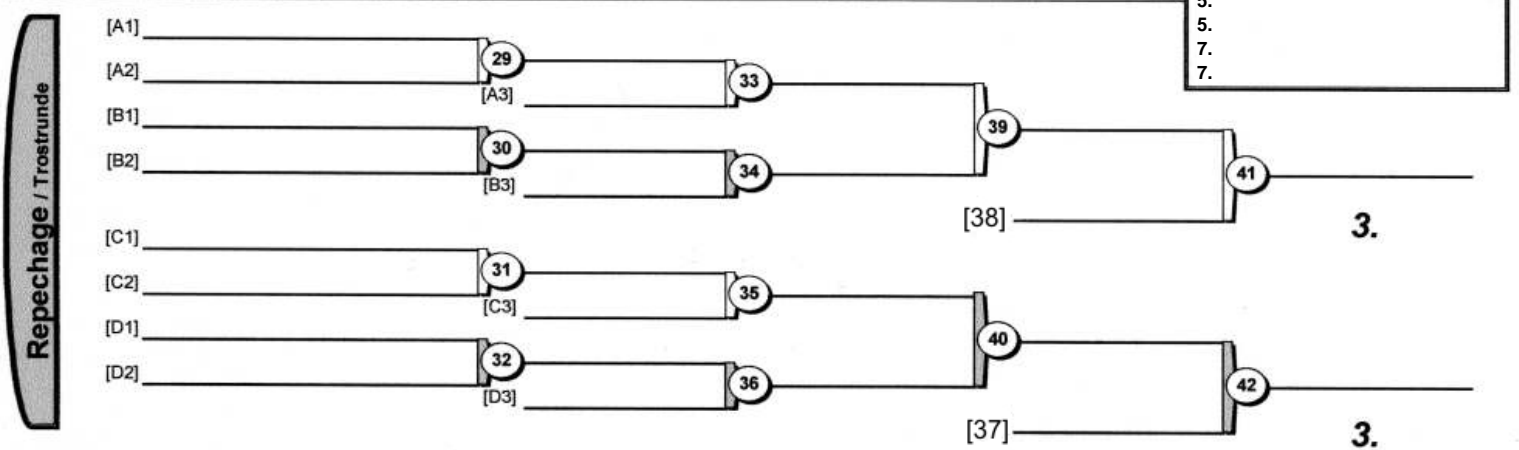

3.

3.

Cadet European Judo Cup Cluj - Napoca 2019

Cluj - Napoca (ROU), 04-05 May 2019

-90 kg

32 Judoka

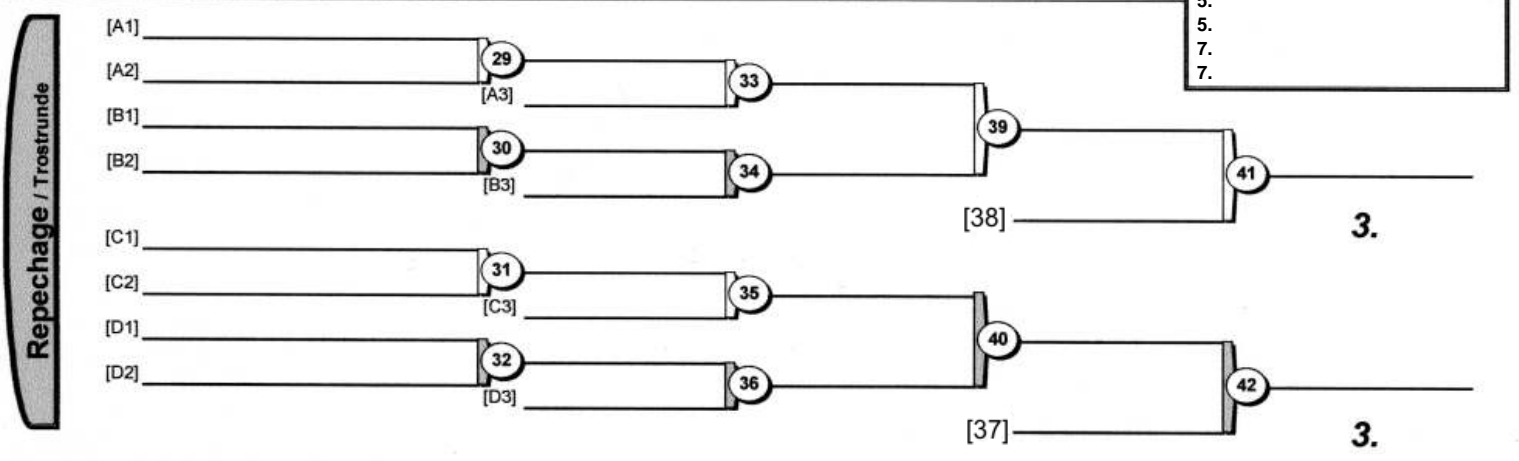
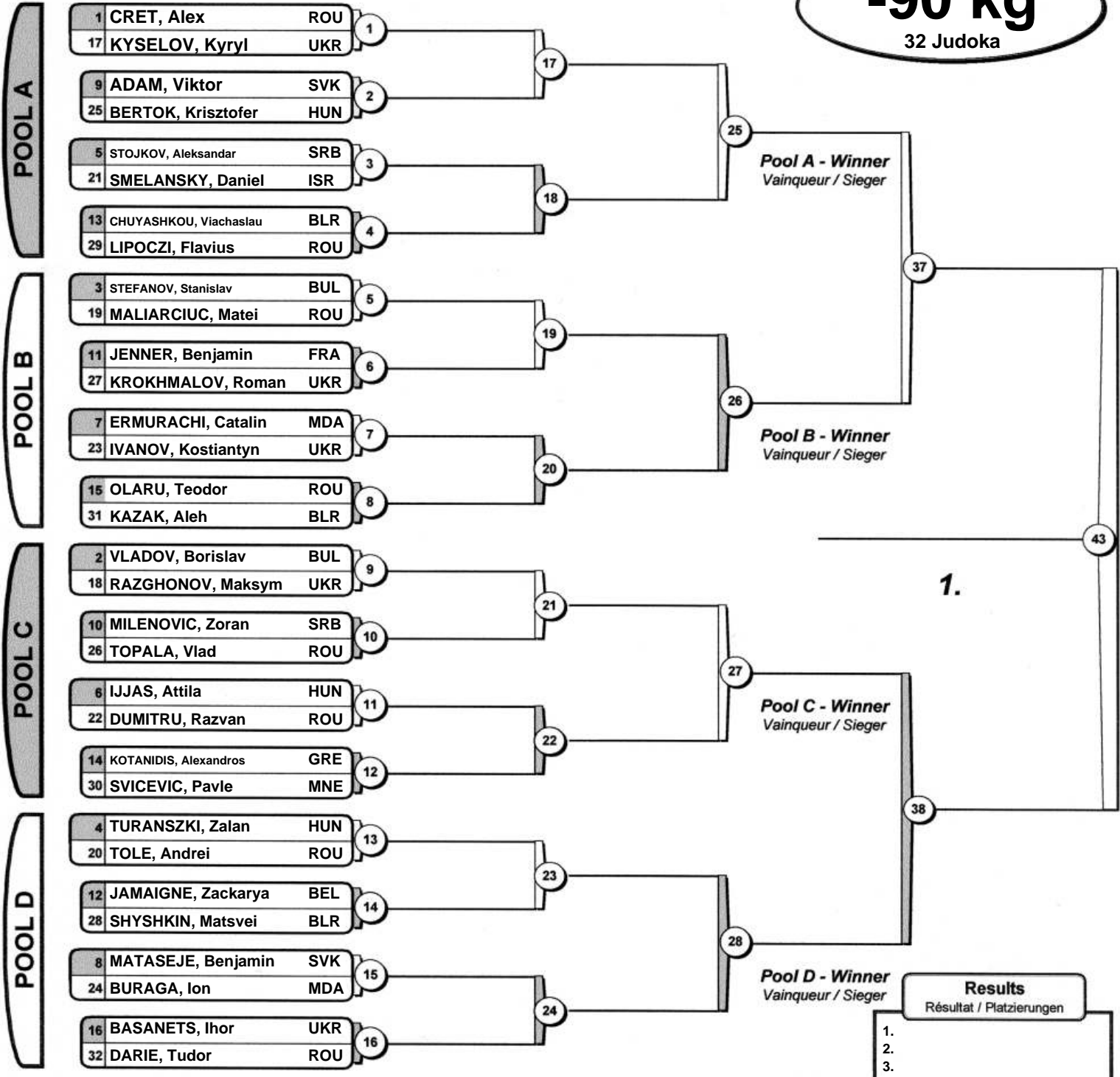

Cadet European Judo Cup Cluj - Napoca 2019

Cluj - Napoca (ROU), 04-05 May 2019

+90 kg

21 Judoka

POOL A

1	ANGLIONIN, Mathias	FRA	1	ANGLIONIN, Mathias
17				17
9	FILIPOV, Lyuben	BUL	2	
25	IONUTI, David Cristian	ROU		25
5	HONCHAROV, Mykhailo	UKR	3	HONCHAROV, Mykhailo
21				18
13	KURDI, Benedek	HUN	4	KURDI, Benedek
29				

Pool A - Winner
Vainqueur / Sieger

POOL B

3	STARAVOITAU, Mikita	BLR	5	STARAVOITAU, Mikita
19				19
11	KHADZHIMURADOV, Abdoullah	FRA	6	
27	MUCENICA, Emil	ROU		26
7	STOSIC, Andrija	SRB	7	STOSIC, Andrija
23				20
15				
31	TURC, David	ROU	8	TURC, David

Pool B - Winner
Vainqueur / Sieger

POOL C

2	TADIC, Branko	BIH	9	TADIC, Branko
18				21
10	STOICA, Cristian	ROU	10	
26	DIMITROV, Yordan	BUL		27
6	CADJENOVIC, Djordje	MNE	11	CADJENOVIC, Djordje
22				22
14	BOGOVAC, Vuk	SRB	12	
30	PICHENET-MARGATHE, Romain	FRA		38

Pool C - Winner
Vainqueur / Sieger

POOL D

4	BAGRIN, Alin	MDA	13	BAGRIN, Alin
20				23
12	ERTUG, Munir	TUR	14	
28	FONDELLI, Andrea	ITA		28
8	NURIEV, Kariim	UKR	15	NURIEV, Kariim
24				24
16	FARCAS, Petru	ROU	16	FARCAS, Petru
32				

Pool D - Winner
Vainqueur / Sieger

1.

Results
Résultat / Platzierungen

- 1.
- 2.
- 3.
- 3.
- 5.
- 5.
- 7.
- 7.

Repechage / Trostrunde

[A1]					
[A2]		29		33	
[B1]			[A3]		
[B2]		30		34	
			[B3]		
[C1]					[38]
[C2]		31		35	
[D1]			[C3]		
[D2]		32		36	
			[D3]		
					[40]
					[41]
					[39]
					[42]
					[37]

3.

3.

Cadet European Judo Cup Cluj - Napoca 2019

Cluj - Napoca (ROU), 04-05 May 2019

-40 kg

8 Judoka

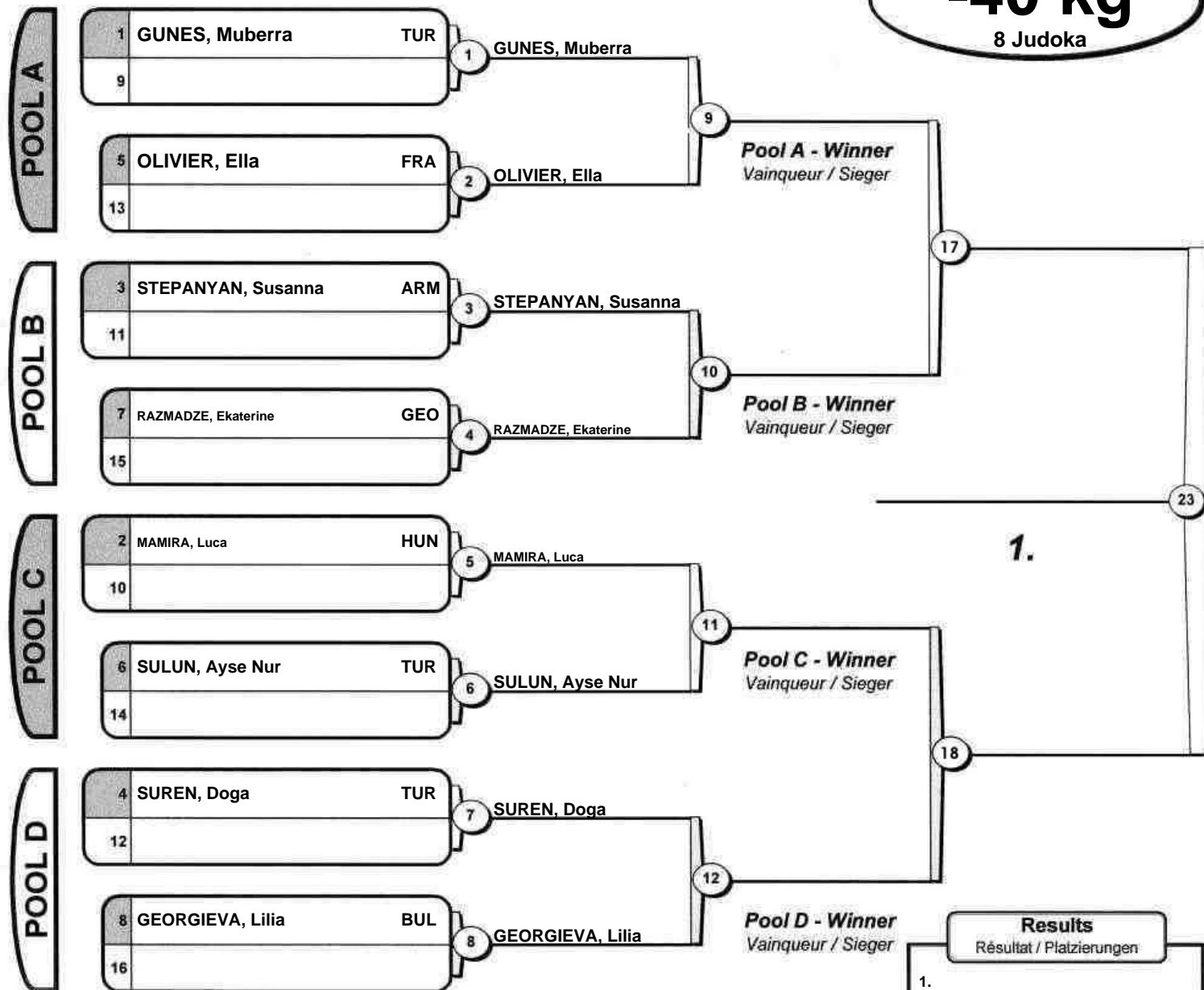

Results	
Résultat / Platzierungen	
1.	
2.	
3.	
3.	
5.	
5.	
7.	
7.	

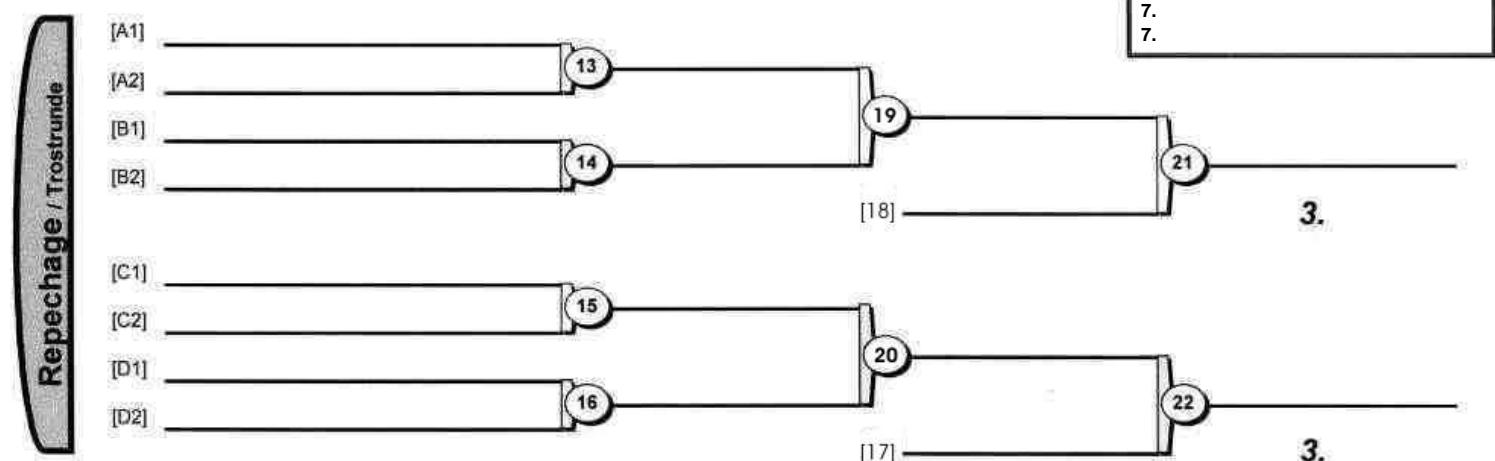

Cadet European Judo Cup Cluj - Napoca 2019

Cluj - Napoca (ROU), 04-05 May 2019

-44 kg

22 Judoka

POOL A

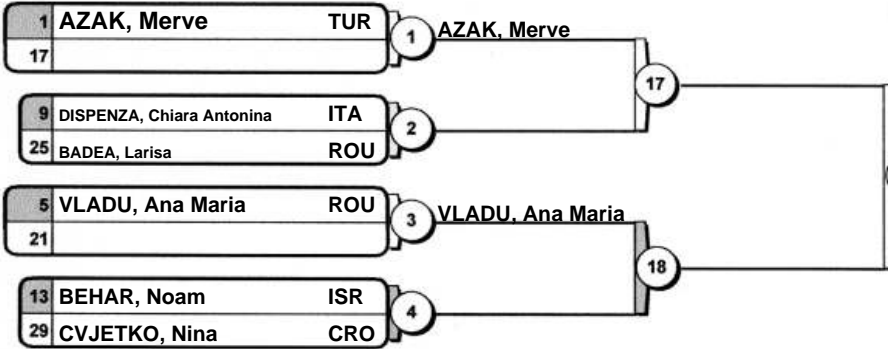

Pool A - Winner
Vainqueur / Sieger

POOL B

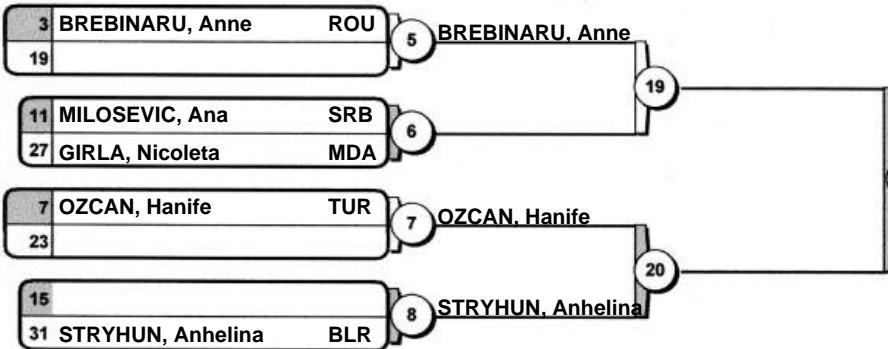

Pool B - Winner
Vainqueur / Sieger

POOL C

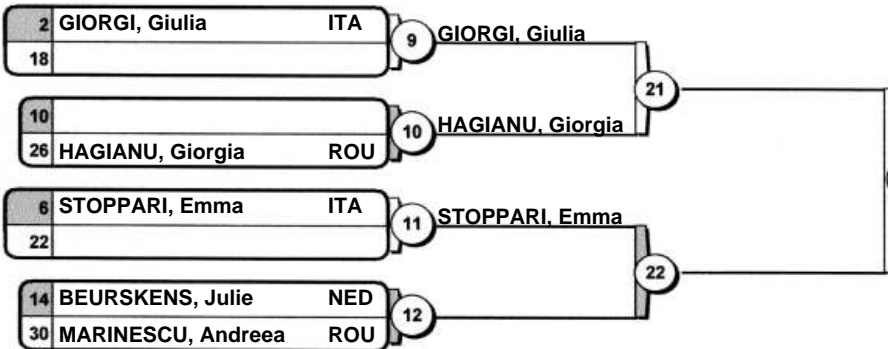

Pool C - Winner
Vainqueur / Sieger

POOL D

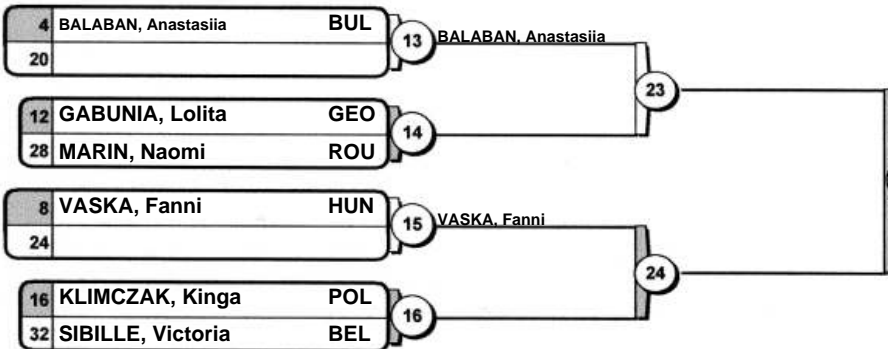

Pool D - Winner
Vainqueur / Sieger

1.

Results
Résultat / Platzierungen

- 1.
- 2.
- 3.
- 3.
- 5.
- 5.
- 7.
- 7.

Repechage / Trostrunde

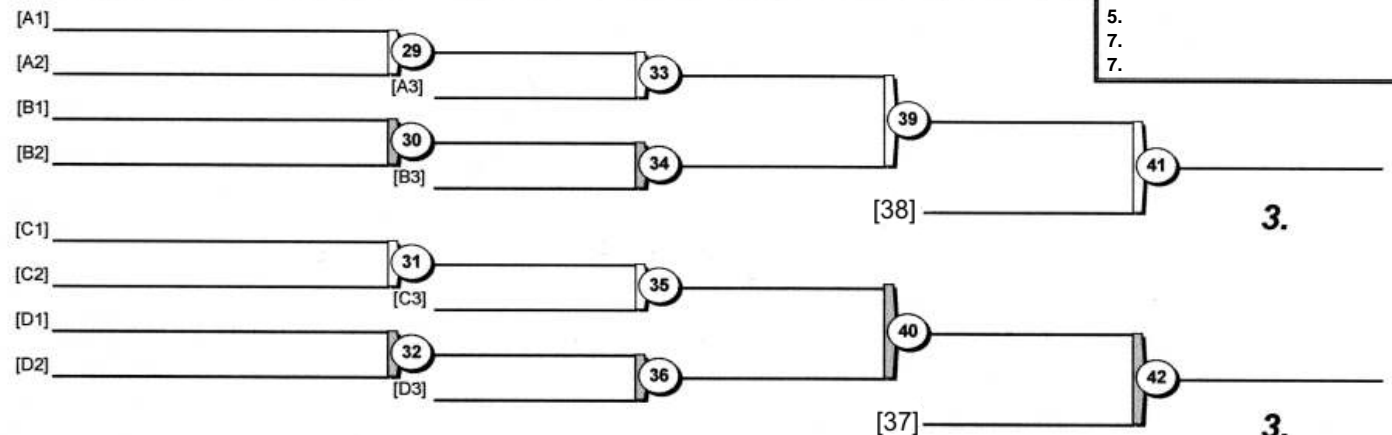

3.

3.

Cadet European Judo Cup Cluj - Napoca 2019

Cluj - Napoca (ROU), 04-05 May 2019

-48 kg

32 Judoka

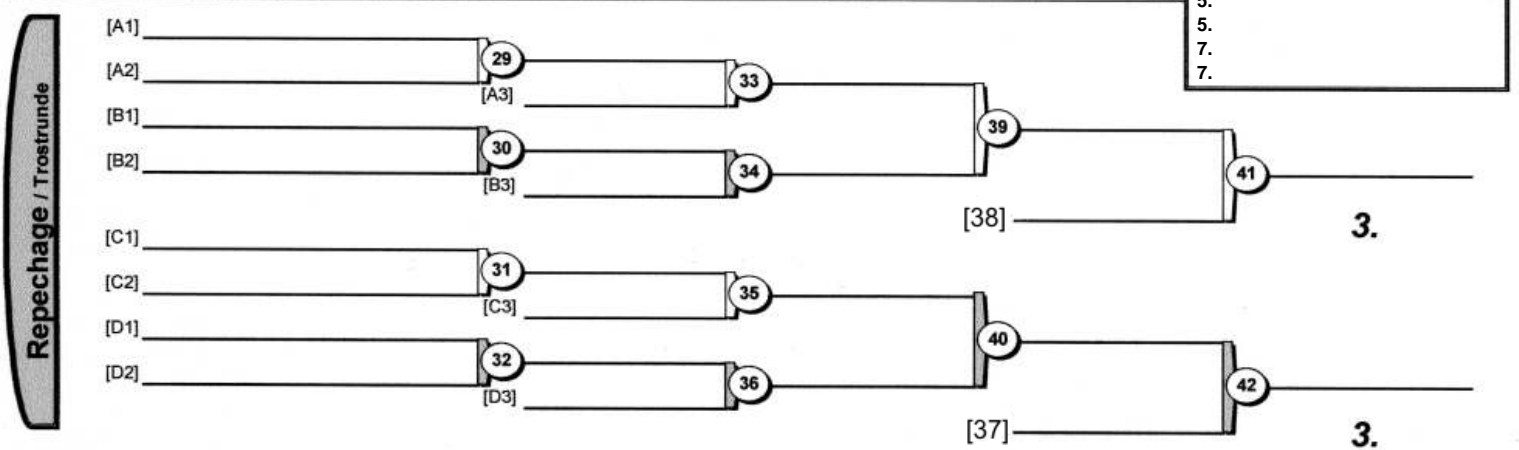
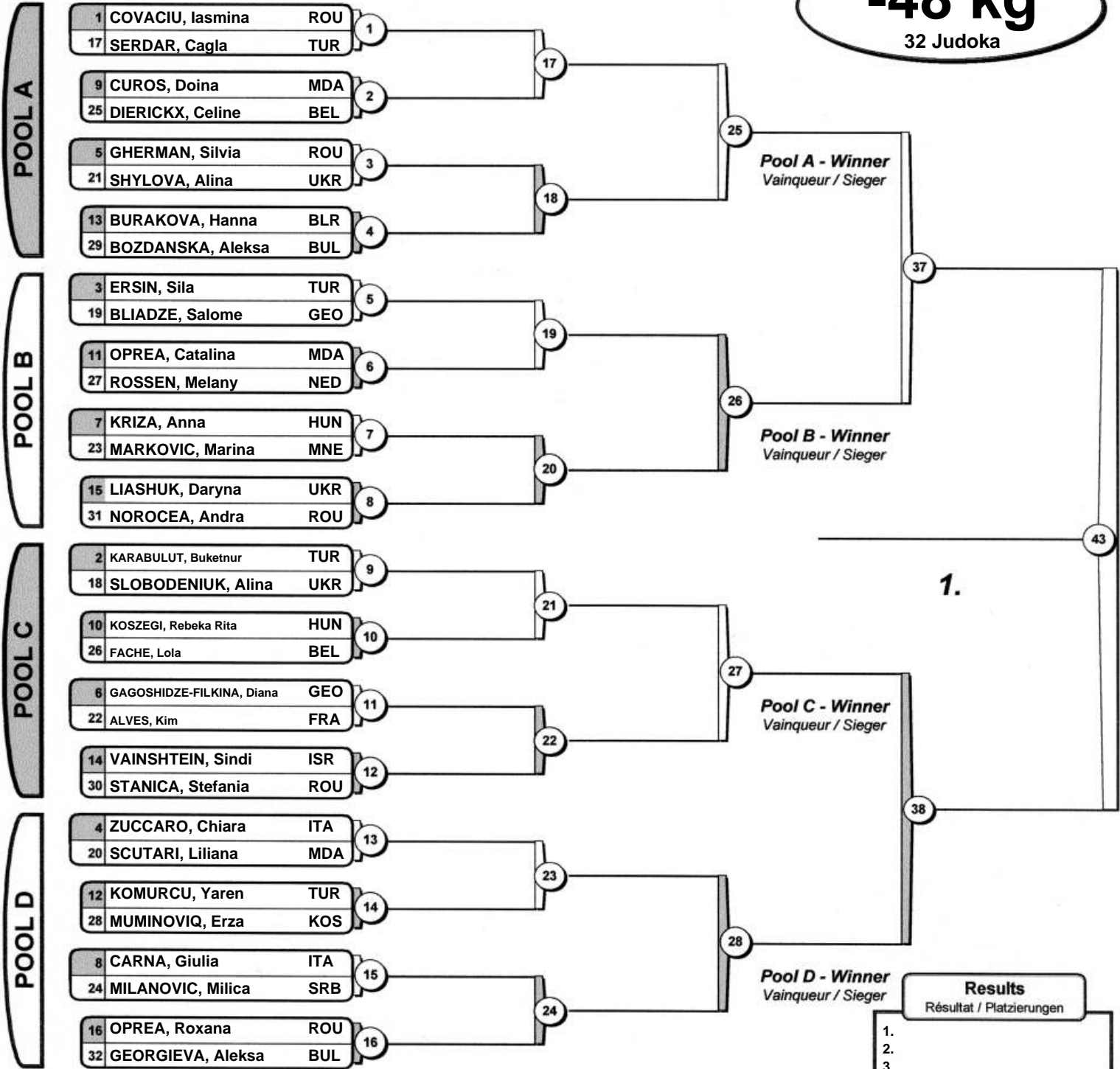

Cadet European Judo Cup Cluj - Napoca 2019

Cluj - Napoca (ROU), 04-05 May 2019

-52 kg

44 Judoka

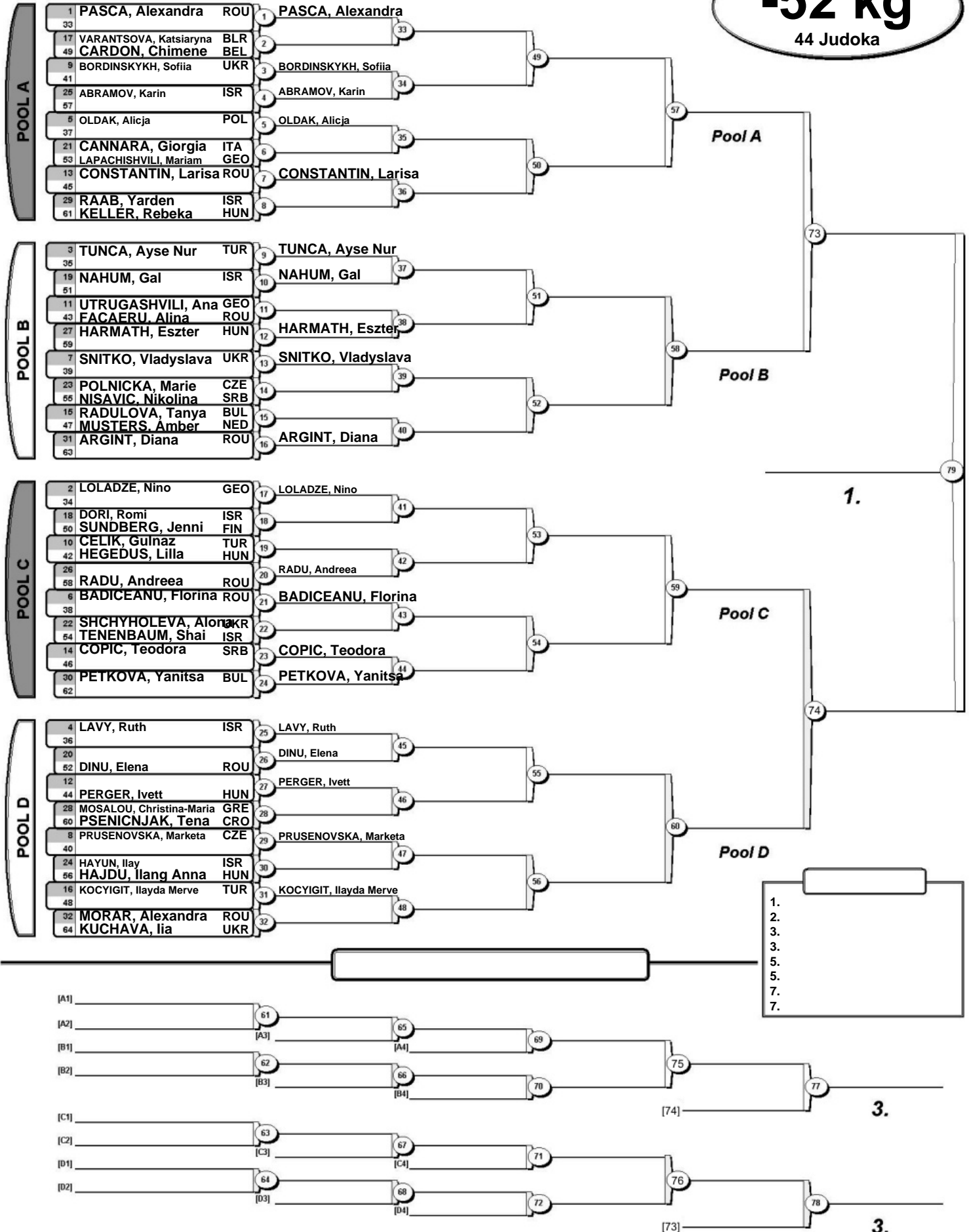

Cadet European Judo Cup Cluj - Napoca 2019

Cluj - Napoca (ROU), 04-05 May 2019

-57 kg

38 Judoka

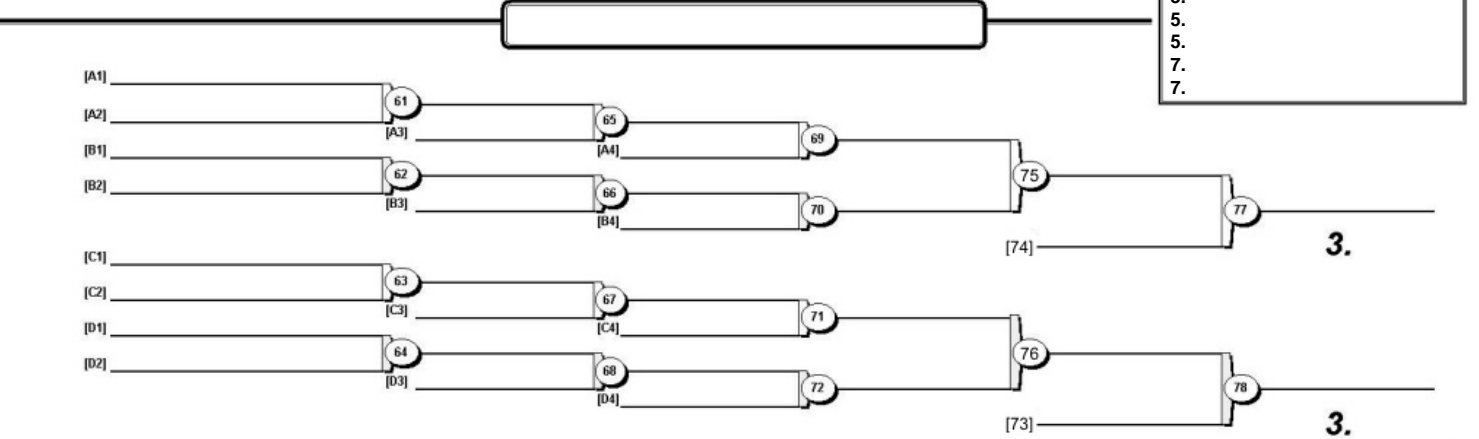
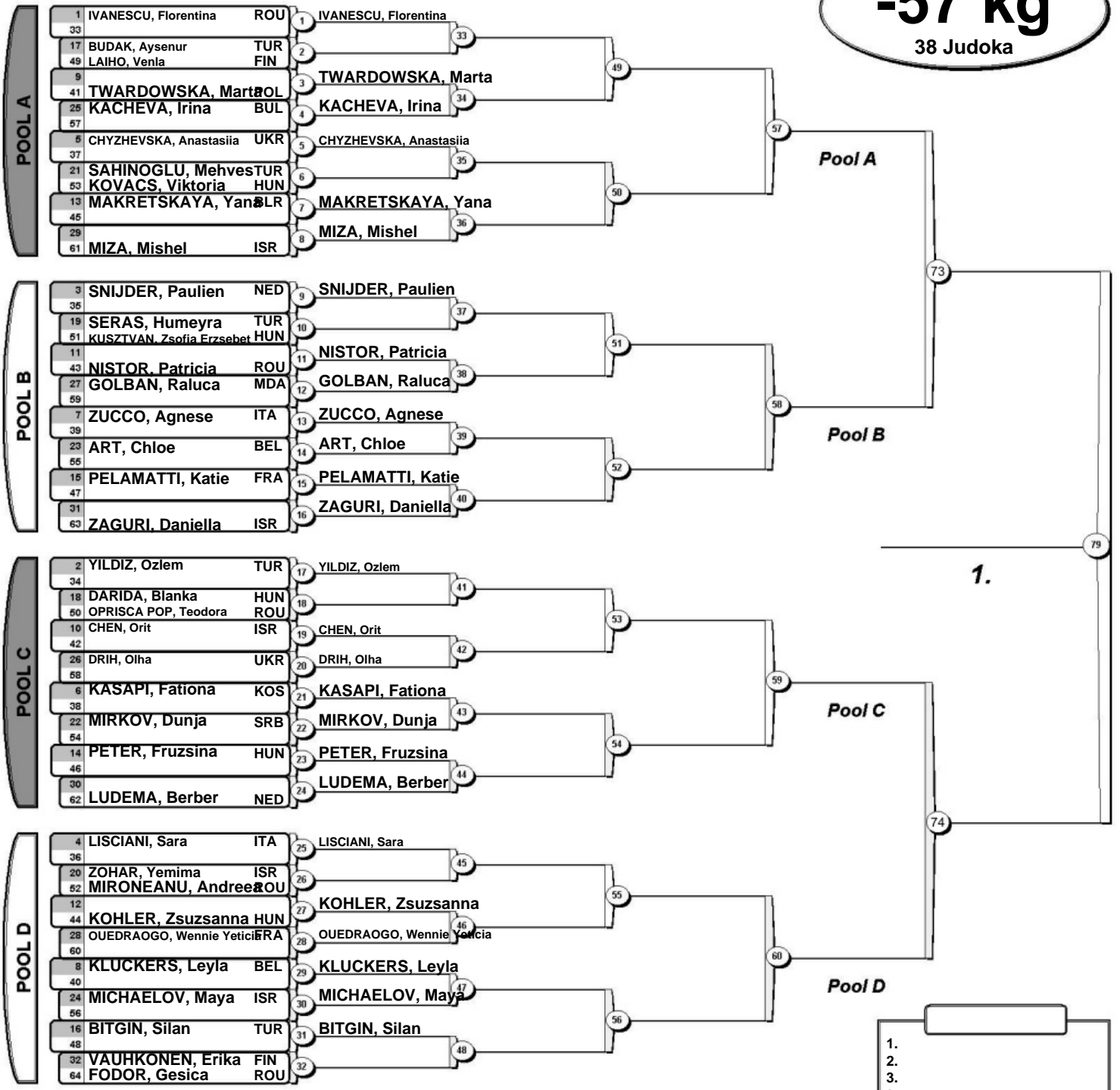

Cadet European Judo Cup Cluj - Napoca 2019

Cluj - Napoca (ROU), 04-05 May 2019

-63 kg

35 Judoka

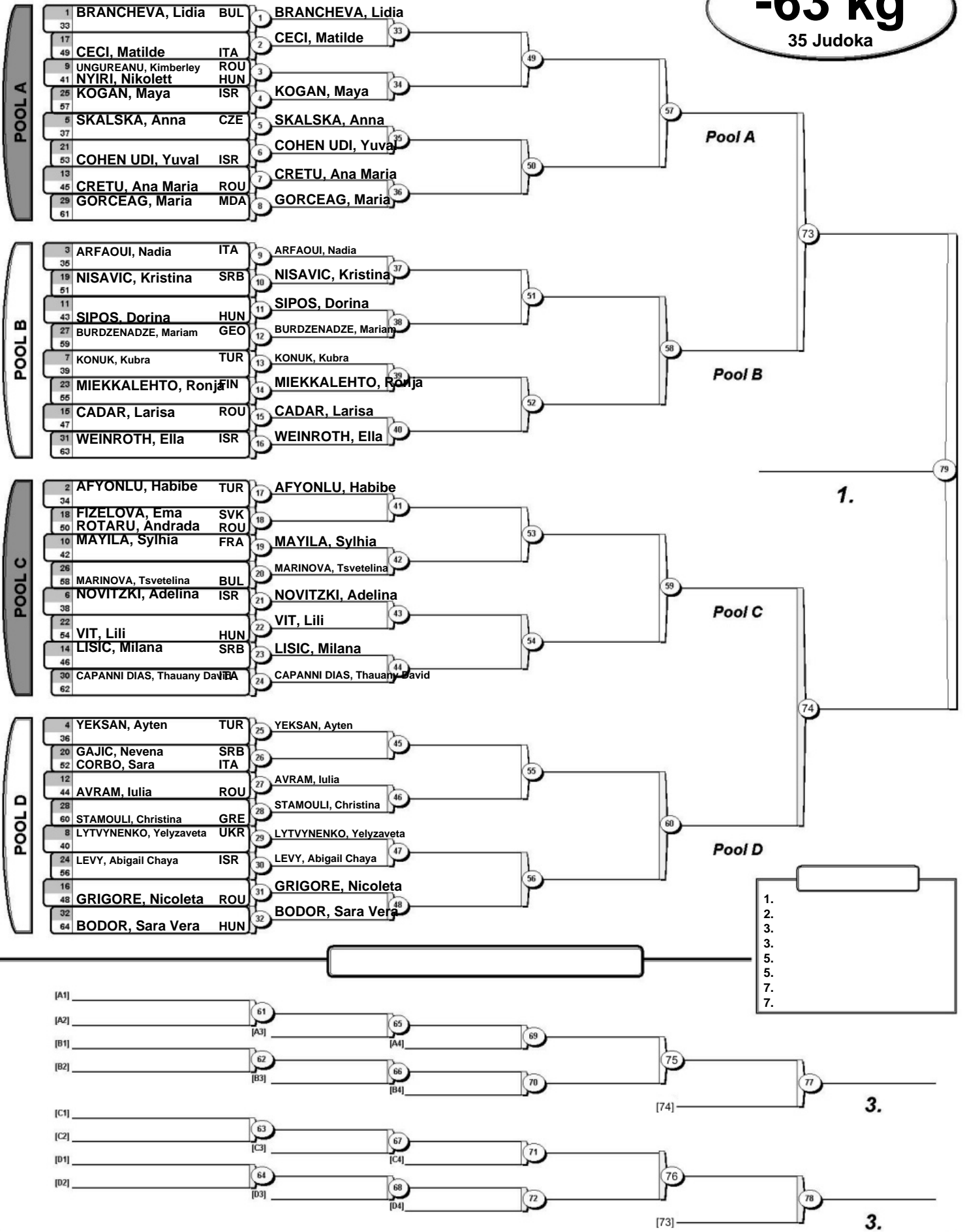

Cadet European Judo Cup Cluj - Napoca 2019

Cluj - Napoca (ROU), 04-05 May 2019

-70 kg

25 Judoka

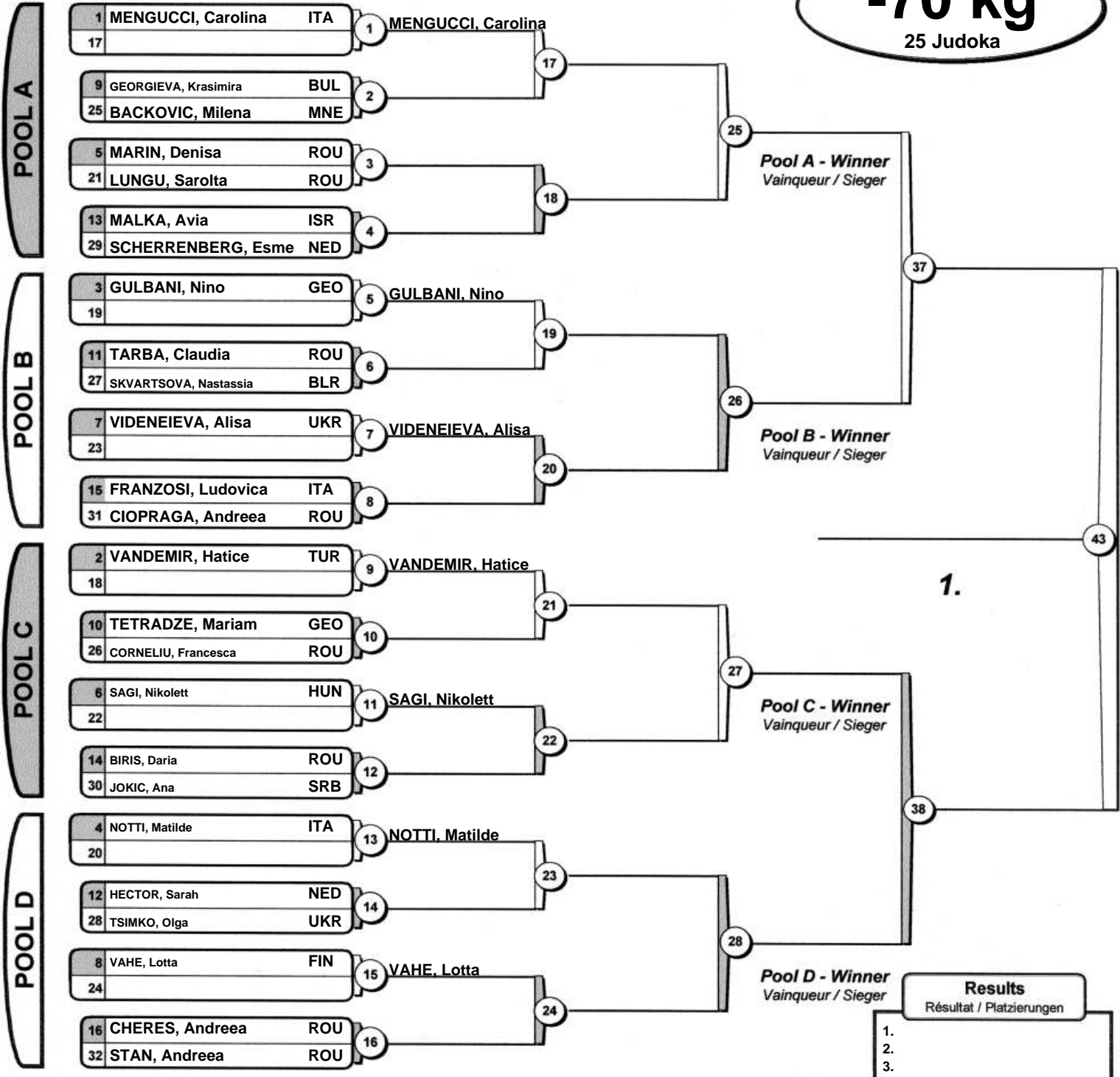

Results	
Résultat / Platzierungen	
1.	
2.	
3.	
3.	
5.	
5.	
7.	
7.	

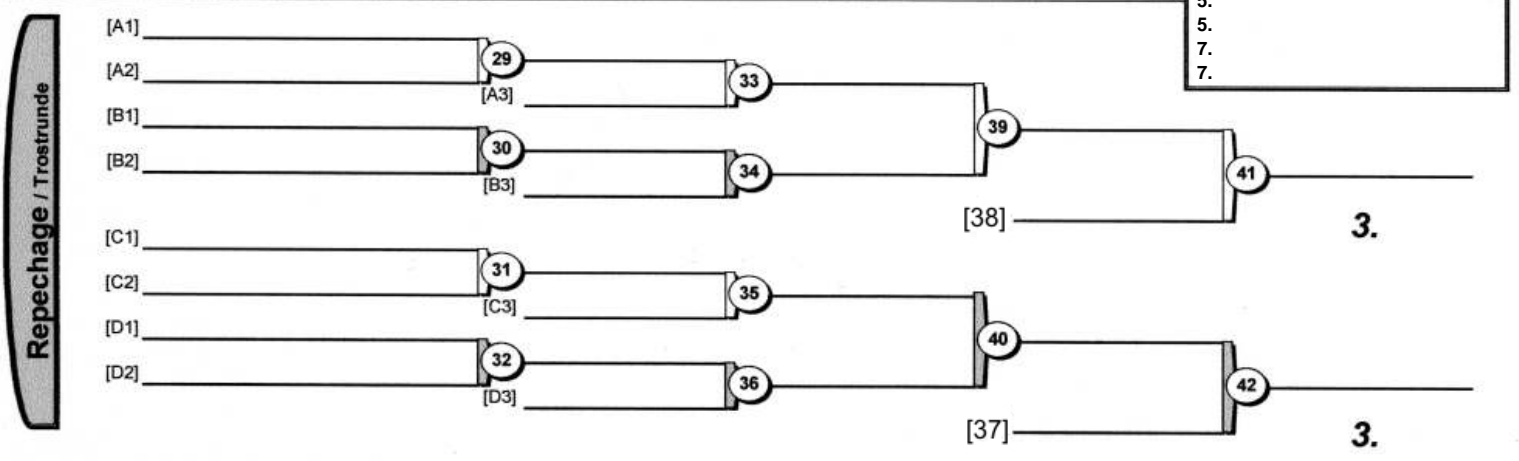

Cadet European Judo Cup Cluj - Napoca 2019

Cluj - Napoca (ROU), 04-05 May 2019

+70 kg

18 Judoka

